

1989

Simultaneous synthesis, sizing and scheduling of multiproduct batch plants

Deepak B. Birewar
Carnegie Mellon University

Ignacio E. Grossmann

Carnegie Mellon University. Engineering Design Research Center.

Follow this and additional works at: <http://repository.cmu.edu/cheme>

Published In

.

This Technical Report is brought to you for free and open access by the Carnegie Institute of Technology at Research Showcase @ CMU. It has been accepted for inclusion in Department of Chemical Engineering by an authorized administrator of Research Showcase @ CMU. For more information, please contact research-showcase@andrew.cmu.edu.

NOTICE WARNING CONCERNING COPYRIGHT RESTRICTIONS:

The copyright law of the United States (title 17, U.S. Code) governs the making of photocopies or other reproductions of copyrighted material. Any copying of this document without permission of its author may be prohibited by law.

**Simultaneous Synthesis, Sizing and Scheduling
of Multiproduct Batch Plants**

by

Deepak B. Birewar, Ignacio E. Grossmann

EDRC 06-79-89³

**SIMULTANEOUS
SYNTHESIS, SIZING AND SCHEDULING
OF MULTIPRODUCT BATCH PLANTS**

Deepak B. Birewar

and

Ignacio E. Grossmann*

**Department of Chemical Engineering
Carnegie-Mellon University
Pittsburgh, PA 15213**

Paper 25d. Annual AIChE Meeting. San Fransisco. November 1989.

***Author to whom correspondence should be addressed**

Abstract

Merging of various processing tasks and using parallel equipment in multiproduct batch plants can help to reduce the overall idle time in the processing units. When this increased efficiency of operations is anticipated together with the scheduling at the design stage significant savings in the capital cost of batch plants are possible. This paper addresses the structural design problem of multiproduct batch plants for deciding which tasks to merge in what units, in what units to use parallel equipment, and the sizing of these units while simultaneously accounting for the production scheduling. MINLP models are proposed that take into account the various complex economic trade-offs involved in these design decisions. Numerical examples are presented to illustrate the scope of this model.

Introduction

Capital cost of multiproduct batch plants can be significantly affected by merging various processing tasks in a single unit or by adding equipment in parallel for bottleneck stages. Such synthesis considerations for structural design add great complexity to the task of sizing multiproduct batch processing plants. Yeh and Reklaitis (1987) have addressed the problem of synthesis and sizing of batch and semicontinuous plants for the production of single product using an evolutionary approach. The synthesis and sizing of a *multiproduct* plant, however, has the additional complication that scheduling must be anticipated at the design stage. Synthesis and sizing procedures for any multiproduct / multipurpose plant cannot be deemed to be complete unless they can properly account for the effect of various scheduling policies on the capacity utilization of batch plants as has been shown by Birewar and Grossmann (1989a) in the optimal sizing problem. Furthermore, the inclusion of finite intermediate storage can also play a crucial role in the synthesis problem as shown by Modi and Karimi (1989).

Most of the work done in the optimal design of multiproduct batch plants has been limited to the sizing of units (e.g. Sparrow et al. 1975; Grossmann and Sargent, 1979; Knopf and Reklaitis, 1982; Yeh and Reklaitis, 1985). Furthermore, most design methods for multiproduct / multipurpose batch plants have typically assumed single product campaigns [SPC 1 with no intermediate storage. In such a policy, scheduling is addressed by a single time constraint based on cycle times of various products (e.g. Sparrow et al, 1975; Grossmann and Sargent, 1979; Yeh and Reklaitis, 1985). The simplified scheduling policy assumed in these methods, often overestimates the time requirements producing oversized plants where their capacity is underutilized. Mixed Product Campaigns on other hand increase the equipment utilization besides assuring a more steady supply of products (Klossner and Rippin, 1984). Birewar and Grossmann (1989a) have addressed the problem of simultaneous sizing and scheduling of multiproduct batch plants and showed that significant economic savings can be obtained. Thus, it is clear that if increased efficiency of operations is anticipated at the stage of synthesis and sizing, cheaper and more efficient designs

can be obtained. Therefore synthesis, sizing and scheduling analysis should be ideally carried out simultaneously. This is indeed quite a difficult problem as even optimizing the schedule in isolation for *fixed* number of Jobs is a nontrivial problem. Also introduction of structural synthesis consideration implies Introduction of discrete decision variables which complicates the solution procedure.

In this paper, a methodology based on MINLP models is proposed for the simultaneous synthesis (or structural design), sizing and scheduling of multiproduct batch processing plants. In particular, it is assumed in this paper that *all products require the same processing tasks in the same order* and that the plants to be designed are of the *Flowshop network type*. The objective is to determine the assignment of processing tasks to the processing units, the number of parallel equipment for each unit and their sizes while accounting for the scheduling so as to minimize the investment cost. In order to address this problem, MINLP models are proposed that incorporate the scheduling equations for mixed product campaigns by Birewar and Grossmann (1989a). Despite the presence of nonconvexities, it is shown that the MINLP problems can be solved successfully with the AP/OA/ER method implemented in *DICOPT++* (Viswanathan and Grossmann, 1989). The MINLP models account for the possibility of using parallel equipment in the various units, as well as the possibility merging various processing tasks. They can also handle SPCs and MPCs with scheduling policies like UIS and ZW. Solution to these MINLP models includes information about the optimal production schedule which can be explicitly generated using the algorithms and the graph representation recently developed by Birewar and Grossmann (1989b). A motivating example is first presented to highlight the importance of including the choices of merging tasks and using parallel equipment, as well as selecting appropriate schedules at the synthesis/sizing stage. Development of the MINLP models is presented next, followed by several examples to illustrate the efficiency of the method. It is also shown that significant economic savings are possible with the proposed *simultaneous* analysis of the three decision processes that are embedded in the overall activity of designing a multiproduct batch plant.

Problem Statement

The problem addressed in this paper can be stated as follows:

It is desired to design a batch plant to produce N_p different products in a sequence of stages. The manufacturing of all of these products requires that they undergo through a sequence of T processing tasks in exactly the same order to obtain the final products. Production requirements Q_i ($i = 1 \dots N_p$) over a given time horizon H , processing times t_{it} and size factors S_{it} ($i = 1 \dots N_p$, $t = 1 \dots T$) are specified for the N_p different products to be manufactured. Cleanup times are assumed to be sequence independent and are part of the processing times. Given also are T types of units, each of which is capable of performing a corresponding task or a subset of the T tasks. The problem then consists in determining the structure of the plant by deciding which tasks should be assigned to which unit, the number of parallel equipment for each of these units and the sizes of the processing units. Also, a production schedule must be determined that will ensure that the plant will be able to meet the production requirements over the given horizon time.

It will be assumed that the plant to be synthesized must be a flowhop network (i.e. a multiproduct plant). In order for this to be true the tasks to be merged in any processing unit need to be adjacent. The cost of each unit is assumed to be given by an equation of the form $y + aVP$ where y is a fixed cost charge and a and p are cost parameters for the unit size V (see Figure 1). The scheduling policies of UIS and ZW will be assumed for both the SPCs and the MPCs.

Motivating Example

A multiproduct batch plant is to be designed to produce 500,000 Kgs of A, 500,000 Kgs of B and 600,000 Kgs of C in a horizon time of 6000 hrs. Each product needs to go through four processing tasks : mixing, reaction, crystallization and drying in that order (Figure 2(a)). There are five types of units available : a cast iron vessel with an agitator, stainless steel vessel with an agitator, jacketed cast iron vessel, jacketed stainless steel vessel with an agitator and a tray dryer (Figure 2(b)). A

maximum of four parallel equipment operating out of phase can be used in any of the processing units. Data on size factors, processing times for various tasks, upper limits on the sizes of units as well as lower limits, data on cost of these equipments are given in Table 1. Figure 2(c) shows the tasks that can be performed by each of the processing units. The cleanup times are assumed to be zero in this case.

As seen from the results in Table 2, if the scheduling is not accounted for, the tasks are not merged and parallel operation of each unit is disallowed, two identical plants operating in parallel would be required (Figure 3(a)). The total capital cost for the two plants is as high as \$ 323,946.7. If parallel equipment and merging of tasks are allowed, still without accounting for scheduling with mixed product campaigns the capital cost reduces to \$ 265,058.9 yielding savings of 18.18 % (Figure 3(b)) by merging the tasks of reaction and crystallization in two stainless steel jacketed vessels operating out of phase in parallel. Also two tray dryers are necessary to be operated in parallel. If MPC scheduling is accounted for, the plant with the ZW policy (Figure 3(c)) involves an investment cost of only \$ 189,107.6 (savings of 41.6 %) while the plant with UIS policy (Figure 3(d)) costs still less at \$ 182,269.5 (savings of 43.73 %). The efficiency of these mixed product campaigns allowed the batch plant to manufacture the given production requirement without using any parallel equipment in four original units. In short, this example shows that determining the proper structure and schedule in the design of a multiproduct batch plant can have a great impact on the investment cost.

Major Trade-offs

As shown in the previous section, the ability to merge various tasks in single processing units as well as to introduce parallel equipment gives rise to important trade-offs in the design of batch plants. As pointed out by Yeh and Reklaitis (1987), for single product plants one can merge tasks so that the cycle time remains the same but the number of units is reduced by increasing the equipment utilization in the remaining units (see Figure 4(a)). Also one can reduce the cycle time by introducing equipment in parallel operating out of phase at the bottleneck unit(s). If done cleverly, the increase in throughput can more than offset the increase in capital cost. As seen

from Figure 4(b) the cycle time reduces from 4 hrs to 2 hrs if an extra parallel unit is added in stage 1. Thus, by increasing the number of units from 2 to 3, the capacity of the plant can be doubled.

However, when dealing with multiple products and more complex scheduling policies than single product campaigns the trade-offs are not so obvious. In general, we can expect the following trends in the two extreme cases for assigning tasks to units :

1. If every task has its own unit, this will lead to the highest number of units, and hence high fixed charge capital costs. It may also potentially create more idle times in various units, and hence less efficient utilization of equipment. However, the cycle times with this arrangements will be the smallest.
2. At the other extreme, if all tasks are merged in say a single unit, this unit will be probably expensive as it is capable of doing all types of operations. The processing time of this unit will be very long as it will be performing all the tasks, which implies that with increased cycle times the number batches will be the lowest and hence the size highest. This too will lead to high capital cost.

Thus, it is necessary to find a proper economic balance by which the number of units can be reduced and equipment utilization is maximized, without greatly increasing the cycle times of the schedule and sizes of the processing stages. In addition, there are also the trade-offs mentioned before for the selection of parallel equipment.

As will be seen in this paper these trade-offs can be explicitly accounted for in MINLP models that properly account for scheduling.

Representation of Alternatives

The solution method to the synthesis, sizing and scheduling of multiproduct batch plants requires developing first a suitable representation of alternative units based on the problem data as described in this section. For simplicity in the presentation, it is assumed that the basic data given consists of information on T processing units, each of which corresponds to one of the processing tasks (Figure 5(a)). These units may also be capable of processing an additional subset of tasks. However, to allow the synthesis procedure to consider all the feasible alternatives for assigning units to tasks in order to avoid excluding the global optimum, it is necessary that the initial available units do not exclude any possible combinations of mergings of tasks. Thus, we *construct* additional processing units that will be denoted as *superunits* which are based on combinations of functions of the existing units and that are capable of performing larger subsets of tasks. A systematic procedure is stated below for constructing all such *superunits*.

Procedure For Constructing Superunits

- Step 1 : Set $V = 2$.
- Step 2 : Go to task t | Construct a set Sf^t of all possible mergings of tasks from $t=l$ to $t=t$ such that
 - each merging consists of at least two tasks
 - the tasks in each merging are consecutively performed
 - the last task in each merging is t'
- Step 3 : If $V < T$, set $f = ? + J$ and go to step 2.
Otherwise STOP.
- Step 4 : For each of the merged elements in set Sf^t , $t' \ll 2 \dots M$ construct a *superunit* that can perform all the tasks belonging to that element. Unless such *superunit* is impossible to construct (e.g. unit has to perform drying as well as mixing of two liquids), or it is same as the unit corresponding to task t | add it to the list of available units along with the

information regarding cost data.

By applying the above procedure, the T initial units plus the additional *superunits* created in step 4, will give rise to a total of M candidate units that can be assigned to T different tasks. In this way, each unit J will be capable to perform a subset of tasks that will be denoted by $J_j, J = 1 \dots M$. The potential assignment of a task to each unit will be denoted by the subsets $J_t, t = 1 \dots T$.

To illustrate, consider the tasks listed in Figure 5(a). Here three tasks, mixing, reaction and crystallization are to be performed. Mixing requires a vessel with an agitator (unit 1). Due to the reaction conditions it is necessary to use a reactor made of stainless steel (unit 2), while the crystallization task requires a Jacketed vessel (unit 3). For $V = 2$, the set S_j^u consists of only one merging of tasks : 1-2. The superunit that can perform both tasks 1 and 2 is a stainless steel vessel with an agitator (unit 4 in Figure 5(b)). For $V = 3$, the set S_j^u consists of the mergings of tasks 2-3 and 1-2-3. Unit 5 and 6 (Figure 5(b)) are the respective superunits corresponding to these merged tasks. Thus, the total number of units that are available for synthesis is $M = 6$, while the potential assignments of the 3 tasks to each of the 6 units are given by $J_1 = \{ 1,3,6 \}, J_2 = \{ 2,3,5,6 \}, J_3 = \{ 4,5,6 \}$ (see Figure 5(b)). The expanded list of available units is necessary to ensure that the global optimum solution is not excluded from the MINLP model for synthesis, sizing and scheduling. It should be noted that the above procedure can easily be extended to the case where more than one initial unit can be assigned to each task.

Another important issue to be considered before developing the MINLP model is the scheduling problem. The next section describes constraints that incorporate scheduling considerations in the synthesis and sizing model.

Scheduling Constraints

For the case when equipment in parallel is not allowed the scheduling and horizon constraints can be derived as described by Birewar and Grossmann (1989ab) :

I. No Equipment In Parallel

Between any two batches that are processed, there will exist some idle time due to the constrained nature of the ZW policy (Birewar and Grossmann, 1989ab). This idle time will be represented by the slacks, SL^j that exist between the batches of products i and k in processing unit J . This slack will depend entirely on the processing times of product i and k in various stages. Hence the following set of relations apply :

$$SL_{ik}^{j+1} + t_{ik}^{j+1} = SL_{ik}^j + t_{ik}^j \quad i, k = 1 \dots N_p, \quad j = 1 \dots M \quad (1)$$

where t_{ik}^j are the total processing times for products i and k in units j and $J+J$ respectively. These processing times depend on the tasks that are performed by the corresponding unit (see equation (17) later in the paper).

For any network flowshop plant the entire schedule can be divided at the level of pairs of batches of various products. By aggregating these pairs of batches in terms of successive pairs of products, $NPRS^j$, we can adequately represent any flowshop schedule (Birewar and Grossmann, 1989b). The variables $NPRS^j$ are then subject to following two groups of assignment constraints :

$$\sum_{i=1}^{N_p} NPRS_{ik}^j = n_t \quad i = 1 \dots J, \quad (2)$$

$$\sum_{k=1}^{N_p} NPRS_{ik}^j = n_k \quad k = 1 \dots J, \quad (3)$$

The total time requirement of the production with ZW policy and MPCs for the number of batches r^j is then given by the following constraints (Birewar and Grossmann, 1989a):

$$\sum_{i=1}^{N_i} V_i + \sum_{j=1}^{N_j} N_j \text{NPRS}^{\wedge} \text{SL}^{\wedge} \leq H \quad j=1..M \quad (4)$$

where H is the horizon time or the total time available for the given production requirements.

Since there will be a single campaign of production for each of the products for SPCs with ZW policy, there will be exactly $n^i - 1$ pairs of batches of product i followed by another batch of product i (Birewar and Grossmann, 1989b):

$$\text{NPRS}_U = n_i - 1 \quad i=1..J, V_p \quad (5)$$

For the UIS policy, there will not be any slacks (Birewar and Grossmann, 1989ab). Thus adding the constraint in (5a) to the constraints in (1) to (4) represent the production with UIS policy for the case of no parallel processing units.

$$\text{SL}_{ikj} = 0 \quad i, j=1..N_r \quad j=1..J, V_p \quad (5a)$$

II. Equipment In Parallel

In this case only the UIS policy for SPCs and MPCs, and the ZW policy for SPCs, will be considered. For defining the number of parallel equipment for each unit, it is first necessary to define the binary variable YC^j such that,

$YC_{0j} = 1$ if the processing unit j does not exist.

$YC_{cj} = 1$ if there are exactly $c \geq 1$ equipment operating in parallel in unit J .

This binary variable is then subject to the following constraint to ensure that exactly one from the options described above is chosen :

$$\sum_{c=0}^{CMAX_j} YC_{cj} = 1 \quad j=1..J, V_p \quad (6)$$

where $CMAX_j$ is the maximum number of equipment that are allowed to operate in

parallel for unit J . The number of parallel equipment, N_j^* for each unit J is then given by the following equation :

$$Af = \sum_{j=1}^{CMAXj} c YC_{cJ} \quad j=1..M \quad (7)$$

Then the number of batches r^* in SPCs with ZW policy can be constrained by the total horizon time from the Inequalities given in Sparrow et al. (1975):

$$\sum_{i=1}^{N_p} n_i \leq H \quad (8)$$

$$N_j^{EQ} T_{L_i} \leq t_{ij} \quad i=1..N_p, \quad j=1..M \quad (9)$$

where T_{L_i} corresponds to the limiting cycle time of product L

Similarly the number of batches r^* in UIS policy can be constrained from the analytical expressions for cycle time of the UIS policy by Birewar and Grossmann, (1989a):

$$\sum_{i=1}^{N_p} n_i t_{ij} \leq H N_j Q \quad j=1..M \quad (10)$$

Having established the basic scheduling constraints, the proposed MINLP model for simultaneous multiproduct batch plant synthesis, sizing and scheduling is described in the next section.

Model for Synthesis, Sizing and Scheduling

We first define some binary variables to denote assignment of tasks to various processing units and existence of these units.

Variable Y_{tj}^* defines the assignment of task t to unit J ,

$$Y_{tj}^* = \begin{cases} 1 & \text{if task } t \text{ is assigned to processing unit } j \\ 0 & \text{otherwise} \end{cases} \quad (11)$$

Each of these tasks need to be assigned exactly once. Hence the following assignment constraint is applicable:

$$\sum_{j \in J_t} r_{tj} = 1 \quad \forall t \in T \quad (12)$$

where J_t is the set of units that are capable of processing task t

Variable YEX_j defines the existence of processing unit J ,

$$YEX_j = 1 \quad \text{if processing unit } j \text{ exists} \\ = 0 \quad \text{otherwise} \quad (13)$$

while variable YF_{jt} defines the first task to be processed in unit J ,

$$YF_{jt} = 1 \quad \text{if } t \text{ is the first task processed in unit } j \\ = 0 \quad \text{otherwise} \quad (14)$$

The total volume requirement, V_j for each task, $t = 1 \dots T$, is dependent on the batch size B_i of each product, $i = 1, \dots, N_p$, and the size factor, S_{it} of product (for task t):

$$V_j = \sum_{i=1}^{N_p} B_i S_{it} \quad \forall t \in T, j=1..M \quad (15)$$

The volume, V^j , of processing unit J has to be large enough to satisfy the volume requirements, V_j of the tasks assigned to them :

$$V^j \geq \sum_{t \in T_j} V_j (1 - Y_{tj}) \quad \forall j=1..M \quad (16)$$

where V^j is the largest size available for the processing unit J and T_j is the set of tasks that can be performed in processing unit J .

The processing time requirement, t_{ij} , of each product i in each unit J is given by the sum of the processing times, t_{ij} , of individual tasks assigned to that unit,

$$t_{ij} \geq \sum_{t \in T_j} t_{it} Y_{tj} \quad \forall i=1..N_p, j=1..M \quad (17)$$

The selected batch size, B_i , for each product i determines the total number of batches, n^i to be produced over the given time horizon. The number of batches times the batch size must be greater or equal than the production requirement, Q_i for each product i :

$$n_i B_i \geq Q_i \quad i=1..M, \quad (18)$$

Also, additional constraints have to be satisfied by the binary variables in order to maintain logical consistency in the MINLP model and to ensure that the plant to be synthesized corresponds to a flowshop network.

The first of such constraints dictates that if a processing unit exists, then at least one task should be assigned to it:

$$\sum_{t \in T_j} y_{tj} \geq YEX_j \quad j=1..M \quad (19)$$

A task can be assigned to a processing unit if that unit exists :

$$y_{tj} \leq YEX_j \quad t \in T_j, \quad j=1..M \quad (20)$$

If a unit exists, then exactly one of the tasks will be the first task to be processed in that unit:

$$\sum_{t \in T_j} y_{tj} = YEX_j \quad j=1..M \quad (21)$$

Any given task can be the *first task to be processed in a unit* in at most one of the units:

$$\sum_{j \in J_t} y_{tj} \leq 1 \quad t=1..T \quad (22)$$

A task t can be the *first task to be processed in a unit* if that task is assigned to that unit:

$$y_{tj} \leq Y_{tj} \quad t \in T_j, \quad j=1..M \quad (23)$$

If task t is the *first task to be processed in unit j* then all the tasks f that are to

be performed before t cannot be assigned to that unit:

$$Y_{fj} \leq 1 - Y_{F_{tj}} \quad \text{for } t \in T_j \text{ and } f < U \quad j = 1..M \quad (24)$$

In order to maintain the network flowshop structure of the resultant multiproduct batch plant, it is essential that only consecutive tasks be assigned to every unit. In other words, if any given task t is assigned to a processing unit J then either that task is the first task to be processed in that unit or the previous task $t-1$ is assigned to that unit:

$$Y_{tj} \leq Y_{F_{tj}} + r_M; \quad \text{for } t \in T_j \text{ and } t-1 \in T_{j'} \quad j = 1..M \quad (25)$$

Furthermore if the task $t - J$ cannot be assigned to unit j , then the task t will have to be the first task to be performed in unit (j) if it is assigned to unit j :

$$Y_{tj} \leq Y_{F_{tj}} \quad \text{for } t \in T_j \text{ and } t-1 \notin T_{j'} \quad j = 1..M \quad (26)$$

The capital cost of the plant where parallel equipment is not allowed, is given by the following equation where for each unit j with volume, V_j , CL_j is the fixed charge cost and OL_j and p_j are the cost coefficients :

$$COST = \sum_{j=1}^M Y_{EXj} Y_j + a_j v/y \quad (27)$$

The capital cost of the plant where parallel equipment is allowed for each unit j is given by:

$$COST = \sum_{j=1}^M N_j [Y_j + CL_j V_j] \quad (28)$$

Finally there are the horizon constraints ((1) - (10)) that define the time requirement of the projected production depending on the scheduling policy to be followed. The constraints described above and in previous section are summarized below:

Design constraints

$$\begin{aligned}
 I, Y & \gg 0 & t=1..T \\
 V_t & * B_i \leq S_u & M.JV, t=1..T \\
 V_j & \leq Z - V_f - V_t (1 - Y_{ij}) & t \in T, j=1..M \\
 t_{ij} & \geq \sum_{i \in T_j} t_{ij}^* Y_{ij} & i=1..N_p, j=1..M \\
 n_i & B_i \geq Q_i & i=1..N_p
 \end{aligned} \tag{A}$$

Logical constraints

$$\begin{aligned}
 \sum_{i \in T_j} Y_{ij} & * YEX_j & j=1..M \\
 Y_{ij} & \leq YEX_j & t \in T_j, j=1..M \\
 \sum_{i \in T_j} YF_{ij} & \leq YEX_j & j=1..M \\
 \sum_{j \in J_t} YF_{ij} & \leq 1 & t=1..T \\
 YF_{ij} & * Y_{ij} & t \in T_j, j=1..M \\
 Y_{tj} & \leq 1 - YF_{ij} & t \in T_j \text{ and } f < t, j=1..M \\
 Y_{ij} & \leq YF_{ij} + Y_{ij} & \text{for } t \in T_j \text{ and } M \in T, j=1..M \\
 Y_{ij} & \leq YF_{ij} & \text{for } t \in T_j \text{ and } t-1 \in T_j, j=1..M
 \end{aligned} \tag{B}$$

Objective Functions

For Single Equipment per Stage :

$$COST = \sum_{j=1}^M YEX_j y_j + a.; V_{ff} \tag{C}$$

For Parallel Equipment:

$$COST = \sum_{j=1}^M N_j^{EQ} [\gamma_j + \alpha_j V_j^{\beta_j}] \quad (D)$$

Horizon Constraints

For Single Equipment per Stage :

$$SL_{ikj+1} + t_{ij+1} = SL_{ikj} + t_{kj} \quad i,k=1..N_p, \quad j=1..M$$

$$\sum_{k=1}^{N_p} NPRS_{ik} = n_i \quad i=1..N_p$$

$$\sum_{i=1}^{N_p} NPRS_{ik} = n_k \quad k=1..N_p$$

$$\sum_{i=1}^{N_p} n_i t_{ij} + \sum_{i=1}^{N_p} \sum_{k=1}^{N_p} NPRS_{ik} SL_{ikj} \leq H \quad j=1..M$$

(E)

For Parallel Equipment

$$\sum_{c=1}^{CMAX_j} YC_{cj} = 1 \quad j=1..M$$

$$N_j^{EQ} = \sum_{c=0}^{CMAX} c YC_{cj} \quad j=1..M$$

$$\sum_{i=1}^{N_p} n_i T_{L_i} \leq H$$

$$N_j^{EQ} T_{L_i} \geq t_{ij} \quad i=1..N_p, \quad j=1..M$$

$$\sum_{i=1}^{N_p} n_i t_{ij} \leq H N_j^{EQ} \quad j=1..M$$

(F)

(G)

(H)

Non-negativity and 0 * 1 constraints

$$r \geq 0$$

$$y_{ij} \cdot YC_{cj} = 0, 1 \quad (I)$$

$$0 \leq y_{ij} \leq 1, YF_{ij} \in \{0, 1\}$$

Note that the binary variables YEX_j and YF^A can be treated as continuous variables that lie between 0 and 1.

The above equations can now be pieced together to form three different MINLPs for simultaneous synthesis, sizing and scheduling of multiproduct batch plants with various scheduling policies :

- Model MINLP1 consisting of equation groups A, B, D, F, G and I for design of batch plant with multiple parallel units per stage with ZW policy scheduling using SPCs.
- Model MINLP2 consisting of equation groups A, B, C, E and I for batch plant with single unit per stage following ZW scheduling with MPCs.
- Model MINLP3 consisting of equation groups A, B, D, F, H and I for batch plant with parallel units following UIS scheduling with SPCs or MPCs.

It should be noted that the horizon constraints in MINLP1, MINLP2 and MINLP3 ensure that the "total cycle time" and not the "makespan^M" of the given production requirement is contained within the available horizon time. This however, should not pose difficulties since the makespan is underestimated by the total cycle time by a very small margin for relatively large number of batches (see Birewar and Grossmann, 1989ab).

Also, the number of predicted batches r^A , will in general not take integer values. Since their magnitude will be large the number of batches can simply be rounded down to the nearest integer. This serves another purpose, too. By rounding *down* the number of batches, the time requirement is reduced which counter-balances the error

stemming from using cycle time as an approximation to the makespan. Since the number of batches involved will often be relatively large, the above rounding scheme should produce solutions that are very near to the global optimum. Note that since the non-integer solution yields a lower bound to the capital cost, one can easily compute the maximum deviation of the rounded solution with respect to the lower bound of the global optimum.

It should be noted that the three MINLP models involve 0 - 1 variables that appear linearly while nonlinearities are involved in continuous variables. Also, equations (4), (8), (9), (10), (27) and (28) are nonconvex. To solve the MINLP problem the AP/OA/ER algorithm implemented in *PROPT++* (Viswanathan and Grossmann, 1989) through the modelling system GAMS (Rueger, 1987) has been used to solve these problems. MINOS 5.2 (Murtagh and Saunders, 1985) was used to solve the NLP subproblem while SCICONIC was used to solve the MILP master problems. Although there is no guarantee of global optimality due to the nonconvexities, this method has performed well on the example problems that have been considered in this paper.

Summary of Design Procedure

The procedure for synthesis, sizing and scheduling of multiproduct batch plants can be summarized as follows :

- **Step 1 :** Based on the given problem data, add to the initial unit list superunits that account for all possible mergings of tasks as described in the section on representation of alternatives.
- **Step 2 :** Formulate the MINLP corresponding to the selected scheduling policy and to the option for parallel equipment (MINLP1, MINLP2 or MINLP3):
 1. Solve the MINLP.
 2. Round off the number of batches obtained in the solution to lower the integer value and resolve the MINLP.
- **Step 3 :** Using the values obtained for the variables $NPRS^i$ in the MINLP

solution, derive the schedule that enables the required amount of products to be manufactured in the new plant in the given horizon time. The schedule is derived using the graph representation and algorithm developed by Birewar and Grossmann (1989b).

Examples

Example 1

This corresponds to the motivating example presented previously in the paper. Four initial units are given for each of the four tasks of mixing, reaction, crystallization and drying (see Figure 2(a) and Figure 2(b)). These four units were 1. Cast iron non-jacketed vessel with an agitator; 2. Stainless steel nonjacketed vessel with an agitator; 3. Cast iron jacketed vessel and 5. Tray dryer. Using the procedure to create *superunits*, the following units were added to the list of available equipment. The set $S|P$ consisted of merging of tasks 1 and 2. As unit 2 is a superset of unit 1 (stainless steel non-Jacketed vessel with an agitator is capable of doing what a cast iron non-jacketed vessel with an agitator can do), no superunit is added at this step. By setting $f = 3$, the set $S|^{u}$ consists of the mergings 1-2-3 and 2-3. Again, as the unit corresponding to task 2 is a superset of the unit corresponding to task 1, only the combination of functions for units 2 and 3 need to be considered. This yields a Stainless steel jacketed vessel with an agitator (see unit 4 in Figure 2(b)). For $t' = 4$, no unit was added as the task of drying cannot be combined with any of the previous tasks. Thus, finally there are five different units available for batch plant synthesis (Figure 2(c)). The cost coefficients and other related data is listed in Table 1. Using this data the problem was solved with MINLP1 (Single Product Campaigns and parallel equipment), MINLP2 (ZW policy and single equipment per unit) and MINLP3 (UIS policy and parallel equipment) with DICOPT++ (Viswanathan and Grossmann, 1989) through the modelling system GAMS (Meeraus and Brooke). As shown in Table 2 MINLP1 involved 87 variables (33 binary) and 149 constraints, MINLP2, 106(8) and 159, MINLP3, 84(33) and 138. The CPU times (and major iterations required) were 5.37 (3), 2.8 (3) and 2.32(3) min respectively on a Microvax n for the solution of the MINLPs and then resolving them with rounded down integer number of batches. The

error arising from the rounding procedure in these .cases was less than 0.1 %. The design for the three cases is shown in Figure 3(b), 3(c) and 3(d).

It should be noted that the two groups of binary variables YEX_j and YF_g need not be actually declared as binaries while solving the above three MINLPs. This greatly reduces the MINLP solution effort. Also note that all the three MINLPs require only three major iterations despite the presence of as many as 33 binary variables (in MINLP1 and MINLP3).

The actual schedules were derived using the graph representation and algorithm developed by Birewar and Grossmann (1989b). For Single Product Campaigns the schedule that fits the given time horizon while satisfying the required production demand is shown in Figure 6(a). Birewar and Grossmann (1989a) have shown that for the UIS policy all schedules exhibit same cycle time. Thus any schedule will suffice. The schedule for ZW policy with MPCs can be derived from the values of the variables $NPRS_{fc}$ obtained from MINLP2 solution using the graph representation method. The actual schedule is shown in Figure 6(b).

Example 2

The batch plant to be designed here is to be used to produce six different products (A to F) for the demands shown in Table 3. A total of 6000 hrs is the horizon time. Each of these products need to go through six steps of processing : mixing, reaction and distillation followed by mixing, reaction and crystallization (Figure 7(a)). For these six tasks the six units that are available are shown in Figure 7(b). After the step of adding *superunits* only one is added to the list of available units (Figure 7(c)). Again we will assume that a maximum of four parallel equipment can be used in any of the processing unit. Figure 7(d) shows the tasks that can be performed by each of the processing units. The cleanup times are assumed to be zero in this case. Data on size factors, processing times for various tasks, upper limits on the sizes of units as well as lower limits, data on cost of these unit are given in Table 3(a) and Table 3(b).

Using this data the problem was solved with MINLP1 (Single Product Campaigns

and parallel equipment), MINLP2 (ZW policy and single equipment per unit) and MINLP3 (UIS policy and parallel equipment) with DICOPT++ (Viswanathan and Grossmann, 1989) through the modelling system GAMS (Meeraus and Brooke, 1987). MINLP1 required 147 variables (46 binary) and 314 constraints, MINLP2, 385(11) and 477, MINLP3, 141(46) and 278. The CPU times (and major iterations required) were 48.3 (4), 18.2 (3) and 9.62 (3) mln respectively on a Microvax II for solution of the MINLPs. The error arising from the rounding procedure in these cases was less than 0.5 %.

As seen from the results in Table 4, if the scheduling is not accounted for, the tasks are not merged and the choice of parallel equipment is disallowed (Figure 8(a)), the total capital cost requirement turns out to be as high as \$ 775,840. The plant involves six different processing units each assigned to one of the tasks. The *superunit* is not used. If parallel units and merging of tasks are allowed, still without accounting for scheduling with mixed product campaigns the capital cost reduces to \$ 713,276, yielding savings of 8.1 % (Figure 8(b)). The savings are achieved by eliminating the cast iron vessel with an agitator and by merging the mixing and reaction tasks (to be performed before distillation) in one single unit (a jacketed cast iron vessel with an agitator). If scheduling is accounted for, the plant with ZW scheduling (Figure 8(c)) involves an Investment cost of only \$ 649,146 (savings of 16.3 %) while the plant with UIS policy (Figure 8(d)) costs still less at \$ 640,201 (savings of 17.5 %). These savings are possible because the better scheduling, when anticipated at the design stage, allowed larger time requirements of the merged mixing and reaction tasks (performed after distillation) to be fitted in the horizon of one single unit, i. e. stainless steel vessel with an agitator. Thus now the batch plant consists of only four processing units for the total of six tasks.

Conclusion

This paper has presented a methodology for the simultaneous synthesis, sizing and scheduling of flowshop networks for multiproduct batch plants. The first step consists of a systematic procedure to generate additional candidate units for merging processing tasks. By considering the potential assignment of units to tasks, the problem is then formulated as an MINLP In which the three following major options were considered : scheduling with single product campaigns (ZW policy) and possibility of parallel equipment; scheduling with mixed product campaigns (ZW policy) and one equipment per unit; scheduling with mixed product campaigns (UIS policy) and possibility of parallel equipment.

As has been shown with the example problems significant economic savings can be achieved with the proposed models in the design of multiproduct batch plants.

Acknowledgement

The authors are grateful to acknowledge financial support from the Engineering Design Research Center at Carnegie Mellon.

References

1. Birewar, D. B.; Grossmann, I. E. "Incorporating Scheduling In The Optimal Design Of Multiproduct Batch Plants". Comp. and Chem. Engg. 1989a, 13, 141-161.
2. Birewar, D. B.; Grossmann, I. E. "Efficient Optimization Algorithms for Zero Wait Scheduling of Multiproduct Batch Plants". I & E C - Research 1989b, 2fi. 1333-1345.
3. Brooke, A.; Kendrick, D.; Meeraus, A. In GAMS;
In GAMS : User's Manual;
Scientific Press, 1988.
4. Grossmann, I. E.; Sargent, R. W. H. "Optimum Design of Multipurpose Chemical Plants". I & E C - Process Des. Dev. 1979, 19, 343-348.
5. Knopf, F. C.; Okos, M. R.; Reklaitis, G. V. "Optimal Design of Batch/Semicontinuous Processes". I & E C - Process Des. Dev. 1982, 21, 79-85.
6. Klossner, J.; Rippin, D. W. T. "Combinatorial Problems In The Design Of Multiproduct Batch Plants - Extension To Multiplant and Partly Parallel Operations", presented at AIChE Annual Meeting, San Fransisco, 1984.
7. Modi, A. K.; Karimi, I. A. "Design of Multiproduct Batch Processes with Finite Intermediate Storage". Comp. and Chem. Engg. 1989, 13, 127-139.
8. Murtagh, B. A.; Saunders, M. A. "MINOS User's Manual" Stanford University, Palo Alto, CA. 1985.
9. Sparrow, R. E.; Forder, G. J. and Rippin, D. W. T. "The Choice of Equipment Sizes for Multiproduct Batch Plants: Heuristic vs Branch and Bound". I & E C - Process Des. Dev. 1975, 14, 197-203.
10. Viswanathan, J.; Grossmann, I. E. "A Combined Penalty Function and Outer-Approximation Method for MINLP Optimization", presented at TIMS/ORSA Meeting, Vancouver, 1989.

10. Yeh, N. C.; Reklaitis, G. V. "Synthesis and Sizing of Batch/Semicontinuous Processes", presented at AIChE Annual Meeting, Chicago, 1985.
11. Yeh, N. C.; Reklaitis, G. V. "Synthesis and Sizing of Batch/Semicontinuous Processes : Single Product Plant". Comp. and Chem. Engrg. 1987, 11, 639-654.

List of Tables

Table 1 : Data for Example 1

Table 2 : Results for Example 1

Table 3(a) : Data for Example 2

Table 3(b) : Data for Example 2 (contd.)

Table 4 : Results for Example 2

Table 1 : Data for Example 1

PRODUCTS [i]	Processing Times [t _i , hrs]				Size Factors: S _{lit} [lit / kg]				PRODUCTION REQUIREMENTS 10, kg]	HORIZON TIME [H hrs]
	MX	RXN	CRYSTL	DRY	MIX	RXN	CRYSTL	DRY		
A	2	8	4	9	2	1.4	1.2	3.5	500,000	6000
B	2	4	3	12	2.5	1.5	1.2	4	500,000	
C	7	4	9	3	3	1.4	1.3	5	600,000	

UNITS [j]	COST DATA			UNIT SIZES	
	Fixed Charge Cost [Y _j]	Cost Coefficient [a _j \$/Ht]	Cost Exponent	Lower Limit	Upper Limit
Nonjacketed, Cast Iron with Agitator	10,000	150	0.6	250	5,000
Nonjacketed, Stainless Steel with Agitator	20,000	225	0.6	250	5,000
Jacketed, Cast Iron	17,500	175	0.6	250	5,000
Jacketed, Stainless Steel with Agitator	25,000	250	0.6	250	5,000
Tray Dryer	20,000	175	0.6	250	15,000

Table 2: Results for Example 1

SOLUTION METHOD	MODEL SIZE		# of Major Iterations	CPU TIME * (min)	CAPITAL COST [\$]
	Number of Variables [Binary]	Number of Constraints			
SIZING WITH SPC SCHEDULING ASSUMPTION [CURRENT]	—	---	---	---	323,947
SYNTHESIS & SIZING WITH SPC SCHEDULING ASSUMPTION f MINLP11	87 [33]	149	3	5.37	265,059
SYNTHESIS, SIZING AND ZW SCHEDULING [MINLP2]	106 [8]	159	3	2.8	189,108
SYNTHESIS, SIZING AND UIS SCHEDULING [MINLP3]	84 [33]	138	3	2.32	182,270

* For solving the MINLPs using DICOPT++ through GAMS on Microvax II.

Table 3(a): Data for Example 2

PRODUCTS [i]	Processing Time ^x [hrs] for Tasks [t]						Size Factors ^j p_{it}^T [kg] for Tasks [t]						PRODUCTION REQUIREMENTS [Q, kg]
	MIX1	RXN1	DISTLN	MIX2	RXN2	CRYSTL	MIX1	RXN1	DISTLN	MIX2	RXN2	CRYSTL	
A	2	8	4	1	6	9	3	1	3	4	2	1	600,000
B	2	4	3	1	5	4	5	4	4	5	3	4	600,000
C	1	6	5	3	7	4	4	2	2	3	2	3	700,000
D	3	5	6	2	9	3	3	2	2	3	1	3	700,000
E	3	7	5	2	8	1.5	3	2	2	4	1	4	200,000
F	2.5	4	4	3	4	2	4	4	4	4	4	5	100,000

HORIZON TIME [H] = 6000 hrs

Table 3(b): Data for Example 2 (contd.)

UNITS [j]	COST DATA			UNIT SIZES	
	Fixed Charge Cost [\$Yj]	Cost Coefficient [«j\$/lit]	Cost Exponent [Pj]	Lower Limit	Upper Limit up
Cast Iron, Nonjacketed with Agitator	45,000	200	0.6	250	15,000
Cast Iron, Jacketed with Agitator	55,000	300	0.6	250	25,000
Distillation Column	70,000	450	0.6	250	30,000
Cast Iron, Nonjacketed with Agitator	45,000	200	0.6	250	15,000
Stainless Steel, Nonjacketed with Agitator	60,000	300	0.6	250	15,000
Cast Iron, Jacketed	50,000	250	0.6	250	15,000
Stainless Steel, Jacketed with Agitator	95,000	550	0.6	250	40,000

Table 4: Results for Example 2

SOLUTION METHOD	MODEL SIZE		# of Major Iterations	CPU TIME* (min)	CAPITAL COST [\$]
	Number of Variables [Binary]	Number of Constraints			
SIZING WITH SPC SCHEDULING ASSUMPTION [CURRENT]	—	---	---	—	775,840
SYNTHESIS & SIZING WITH SPC SCHEDULING ASSUMPTION [MINLP1]	147 [46]	314	4	48.3	711,205
SYNTHESIS, SIZING AND ZW SCHEDULING [MINLP2]	385 [11]	477	3	18.2	649,146
SYNTHESIS, SIZING AND UIS SCHEDULING [MINLP3]	141 [46]	278	3	9.62	640,201

* For solving the MINLPs using DICOPT++ through GAMS on Microvax II.

List of Figures

- Figure 1 :** Unit Cost Model
- Figure 2:** Tasks and Units for Example 1
(a) Tasks To Be Performed
(b) Types of Units and Superunits Available
(c) Potential Assignments of Tasks to Units
- Figure 3:** Batch Plant Designs for Example 1
(a) Merging of Tasks and Parallel Equipment Not Allowed;
SPC Scheduling Assumed
(b) Merging of Tasks and Parallel Equipment Allowed ;
SPC Scheduling Assumed
- Figure 4: (a) Merging of Tasks
(b) Parallel Equipment
- Figure 5 : Units and Task Relationships
(a) Units with Nominal Assignments of Tasks
(b) Potential Assignment of Tasks to Units
- Figure 6 : (a) Schedule for SPCs with ZW Policy
(b) Schedule for MPCs with ZW Policy
- Figure 7 : Tasks and Units for Example 2
(a) Tasks To Be Performed
(b) Types of Units Available
(c) Newly Added Superunit
(d) Potential Assignments of Tasks to Units
- Figure 8:** Batch Plant Designs for Example 2
(a) Merging of Tasks and Parallel Equipment Not Allowed;
Scheduling with SPCs Assumed
(b) Merging of Tasks and Parallel Equipment Allowed;
Scheduling with SPCs Assumed
(c) Merging of Tasks and Parallel Equipment Allowed;
Scheduling with MPCs [ZW]
(d) Merging of Tasks and Parallel Equipment Allowed;
Scheduling with MPCs [UIS]

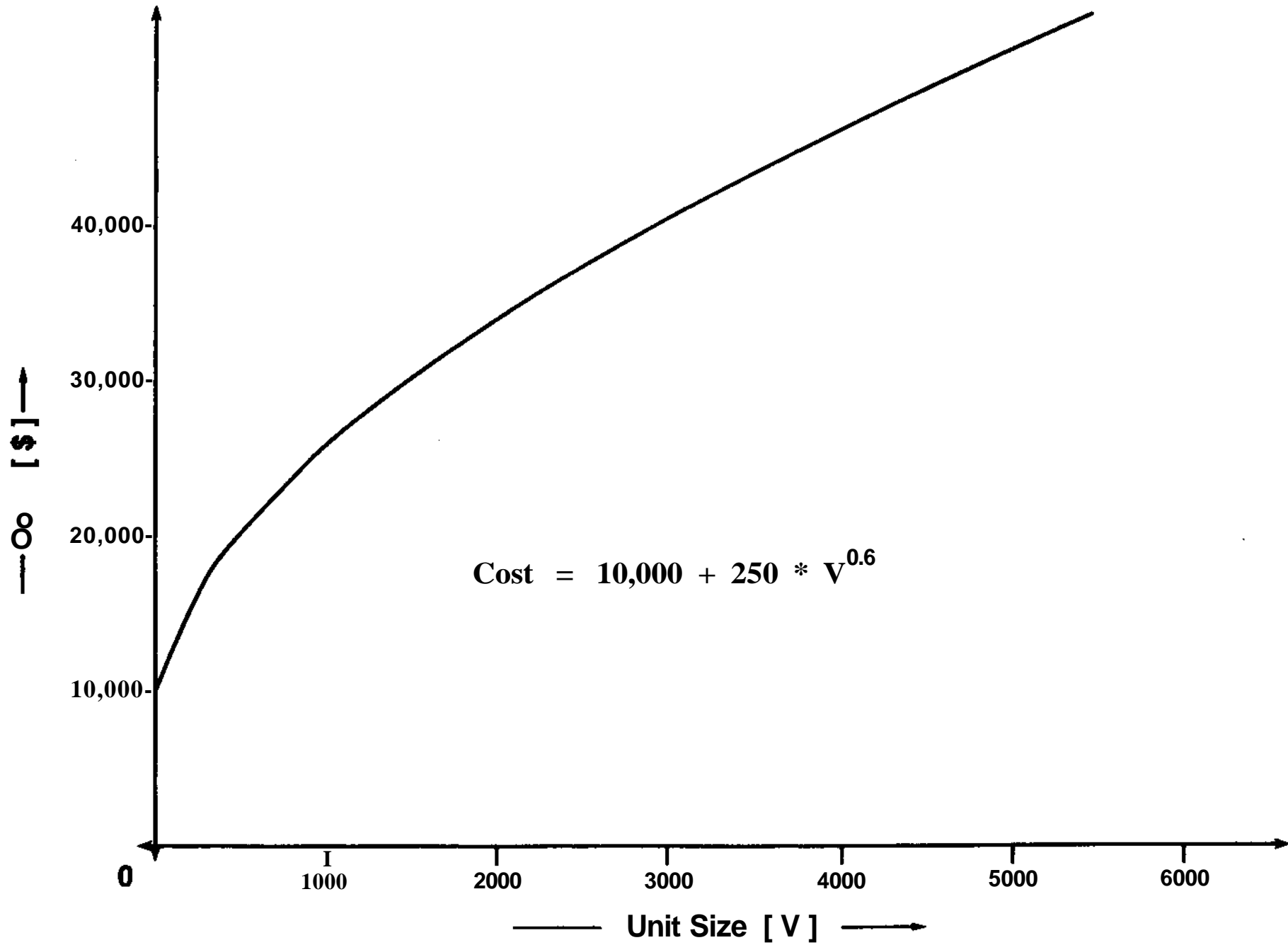
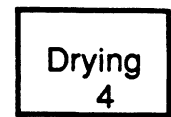
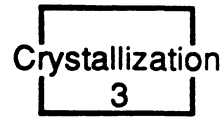
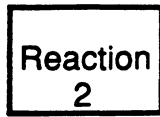
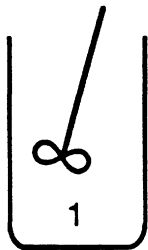

Figure 1 : Unit Cost Model



(a) Tasks To Be Performed

Cast Iron
Nonjacketed
with
Agitator



Stainless Steel
Nonjacketed
with
Agitator

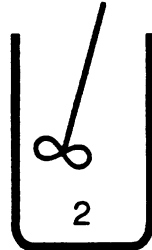

Cast Iron
Jacketed

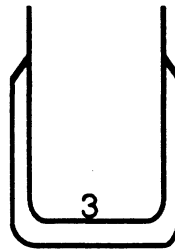

Stainless Steel
Jacketed
with
Agitator

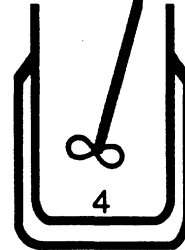

Tray
Dryer

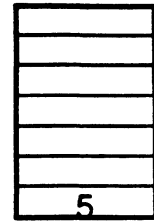

(b) Types of Units and Superunits Available

Unit 1

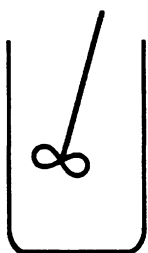

Unit 2

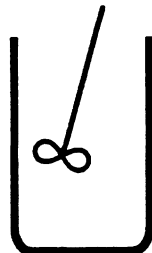

Unit 3

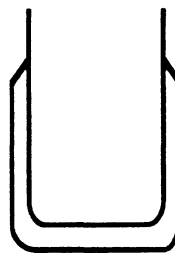

Unit 4

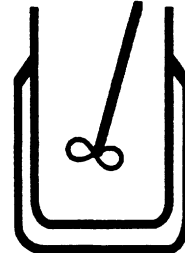

Unit 5

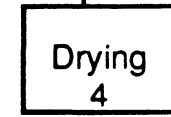
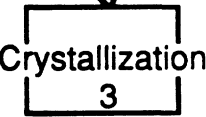
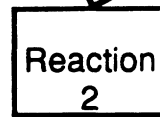
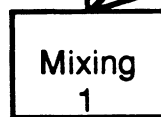
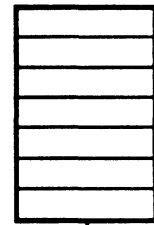

(c) Potential Assignments of Tasks to Units

Figure 2 : Tasks and Units for Example 1

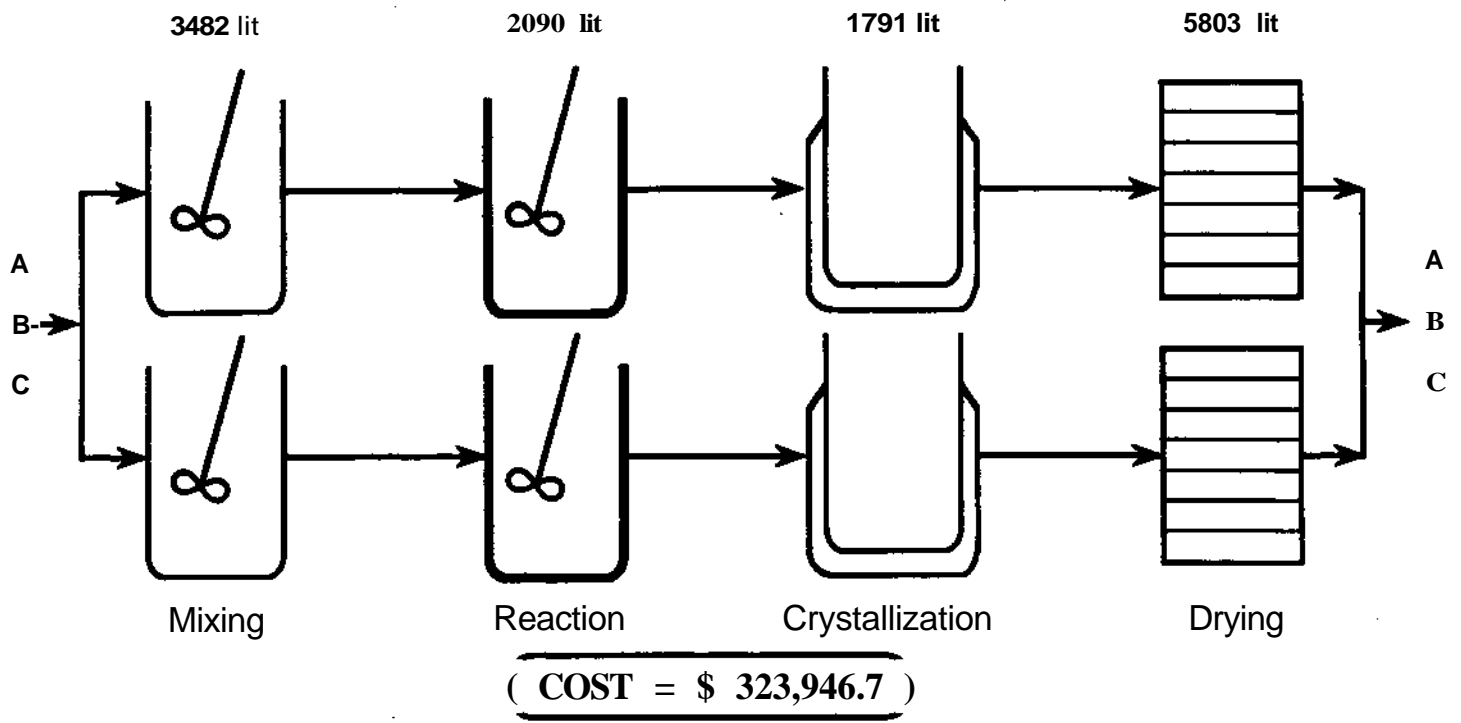

(a) Merging of Tasks and Parallel Equipment Not Allowed ;
SPC Scheduling Assumed

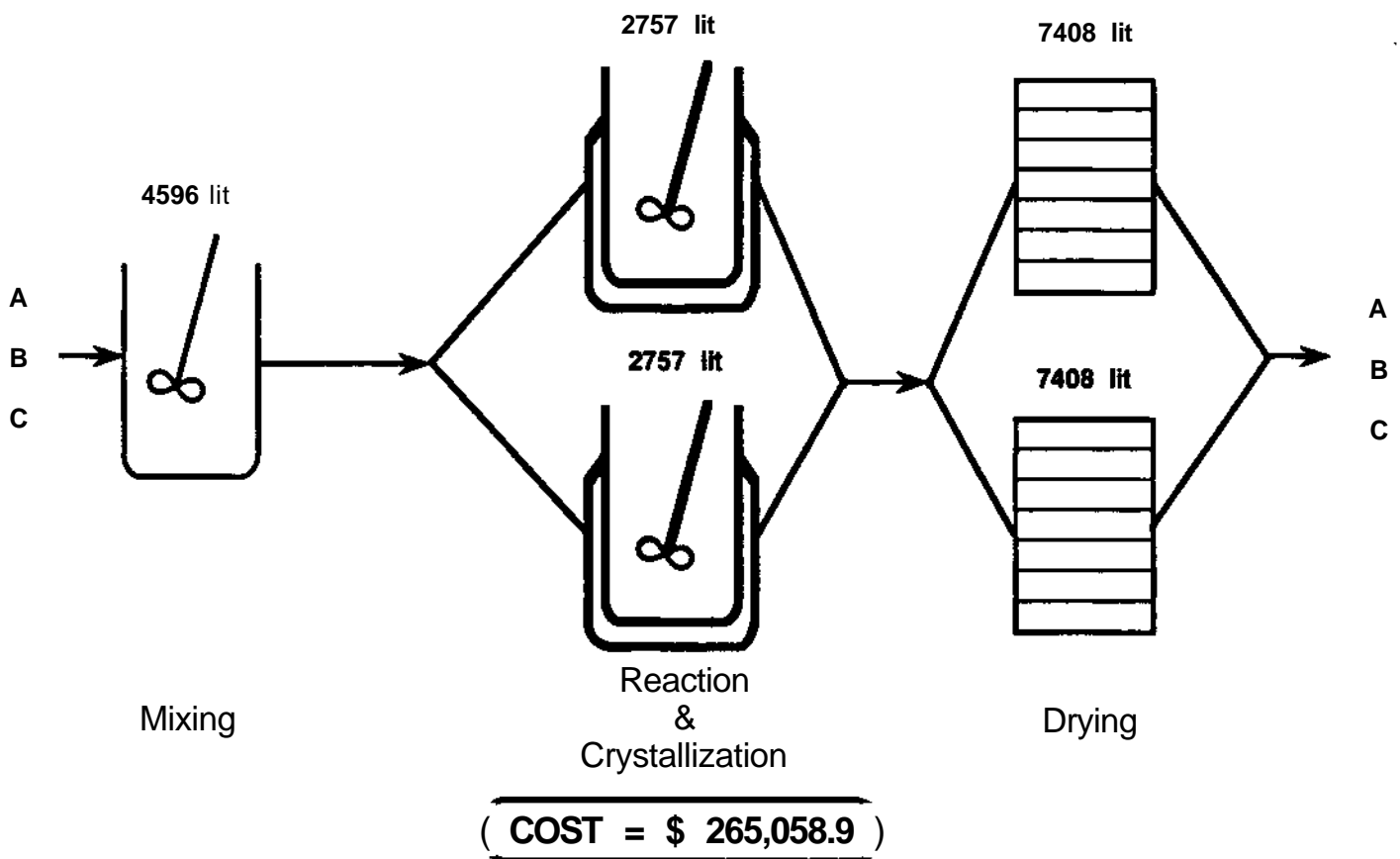

(b) Merging of Tasks and Parallel Equipment Allowed ;
SPC Scheduling Assumed

Figure 3: Batch Plant Designs for Example 1

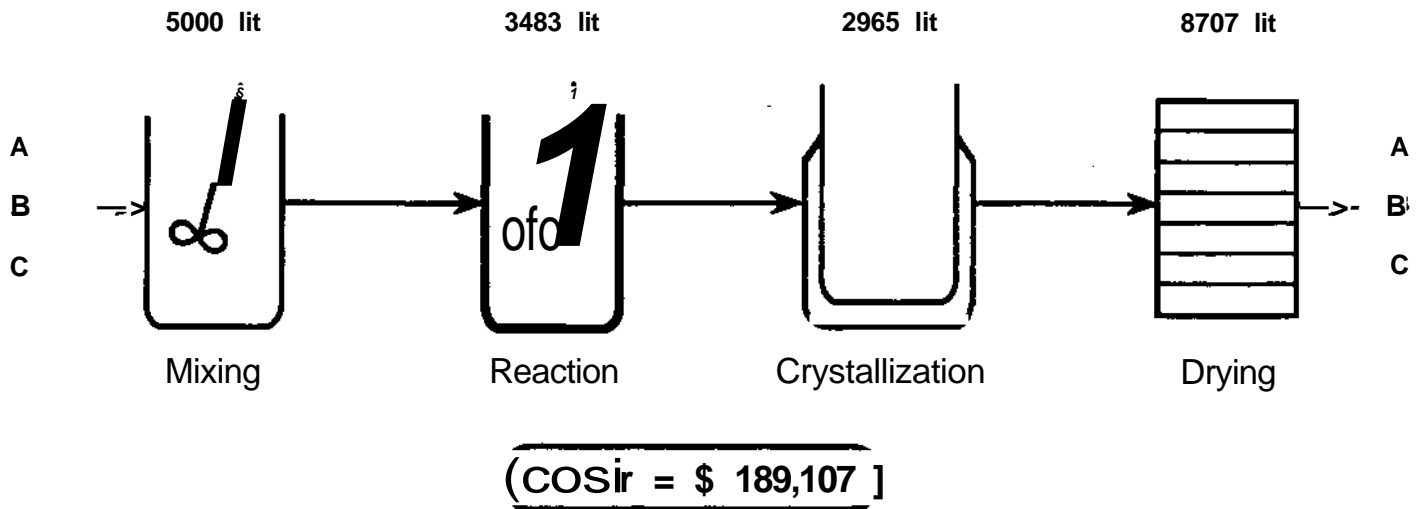

(c) Merging of Tasks and Parallel Equipment Allowed;
MPC Scheduling [ZW Policy]

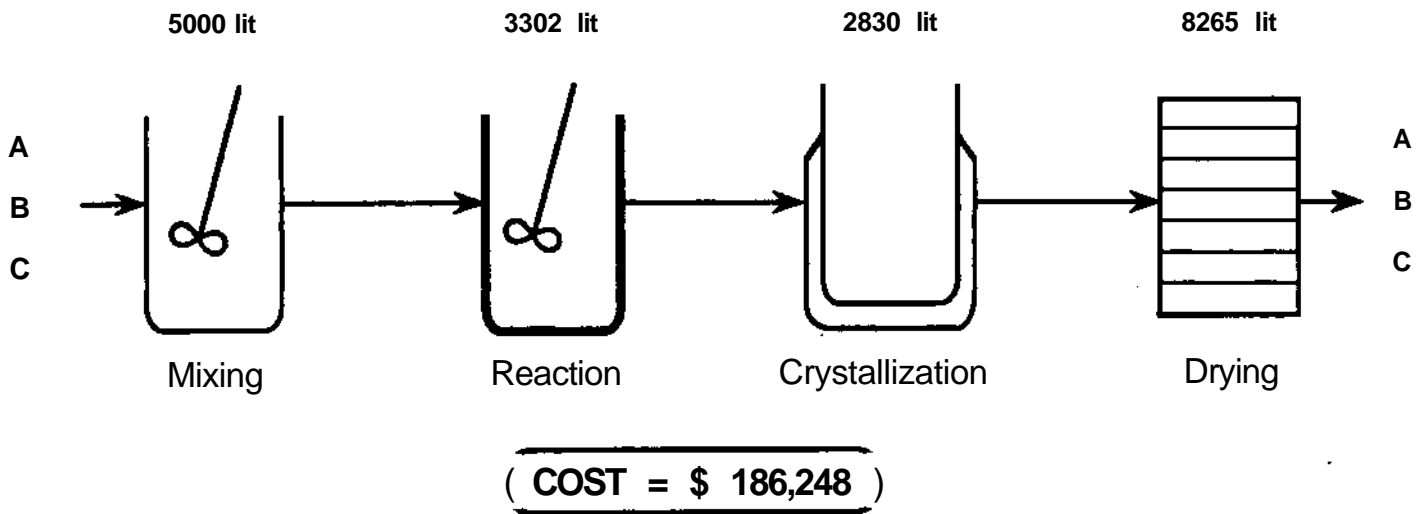

(d) Merging of Tasks and Parallel Equipment Allowed ;
MPC Scheduling [UIS Policy]

Figure 3: Batch Plant Designs for Example 1 (contd.)

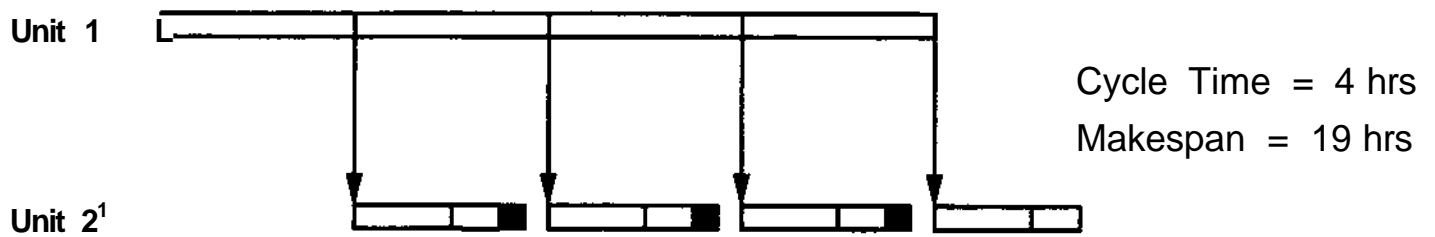
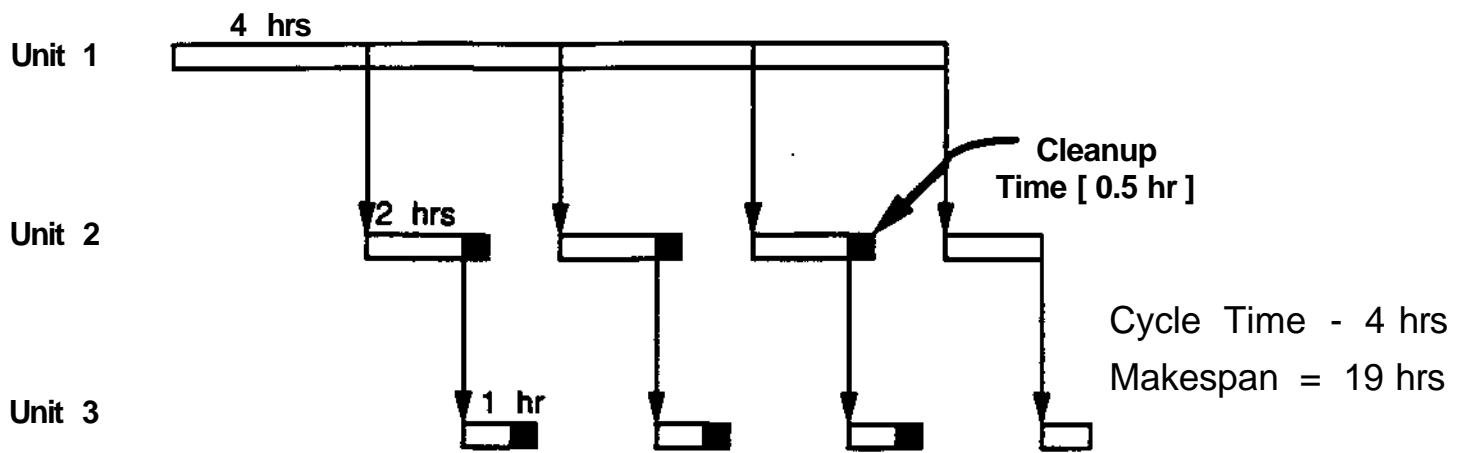

Figure 4(a) : Merging of Tasks

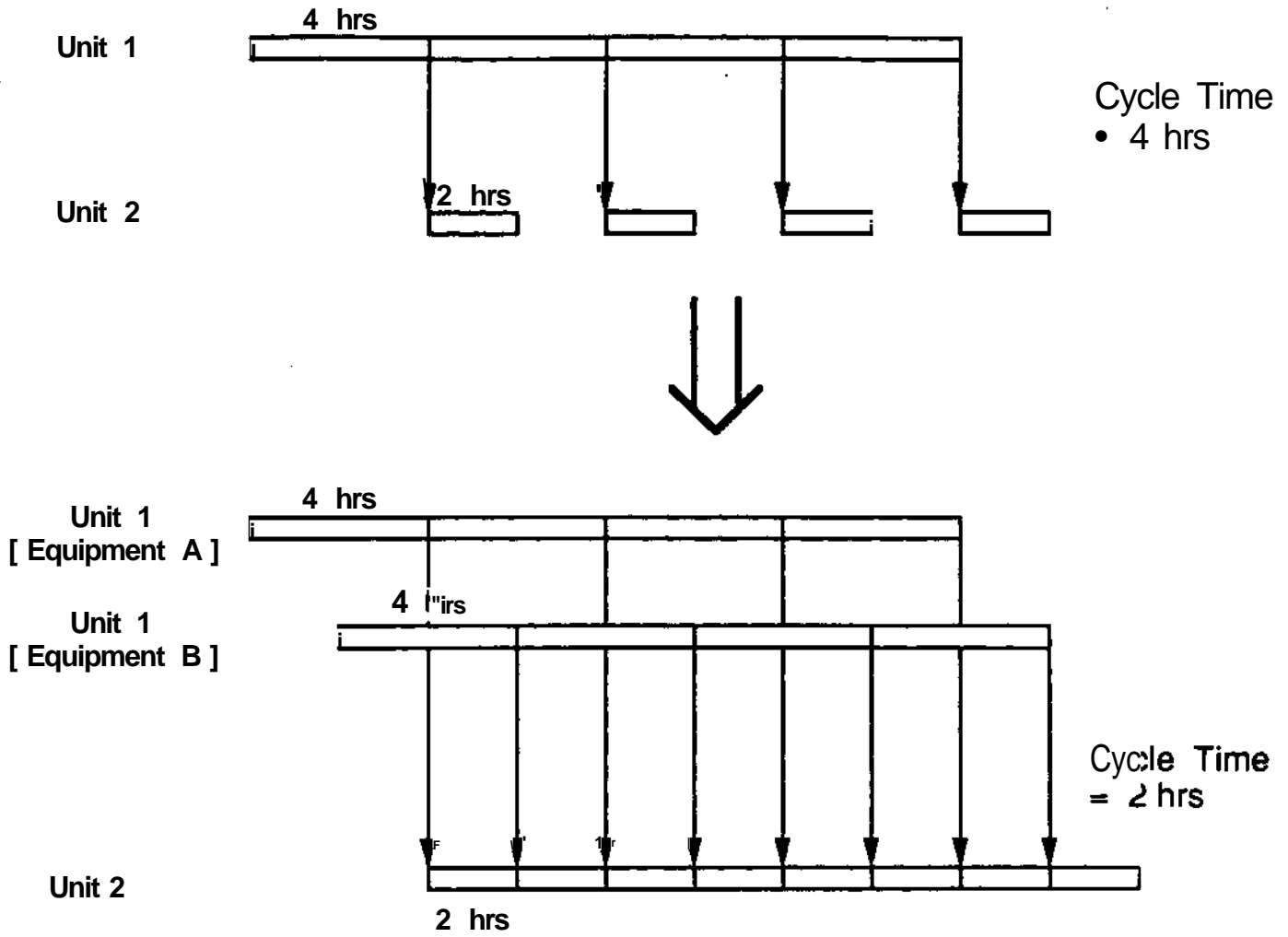
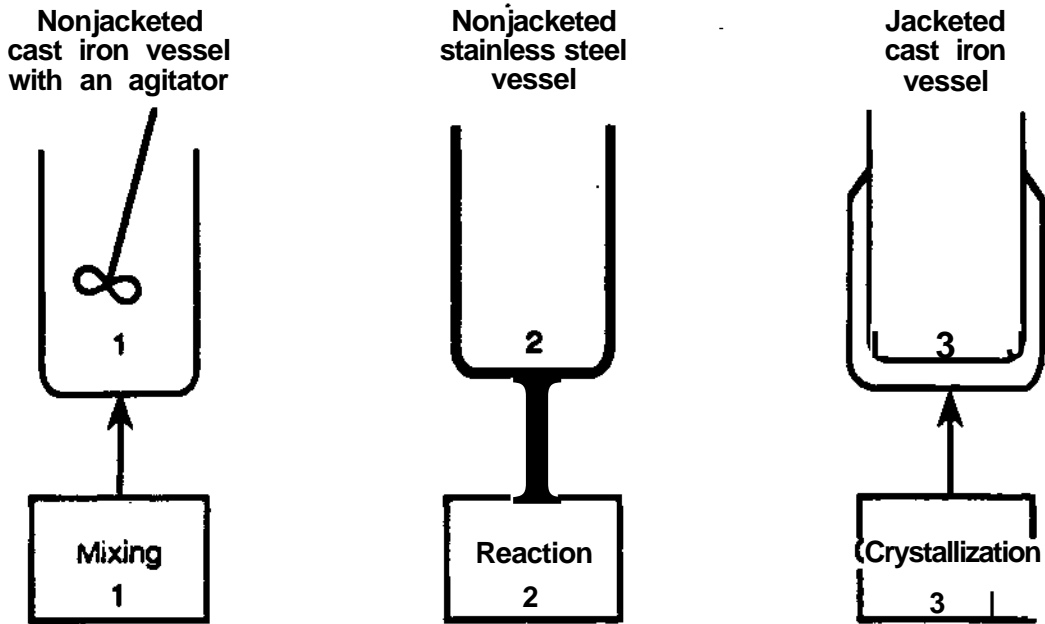
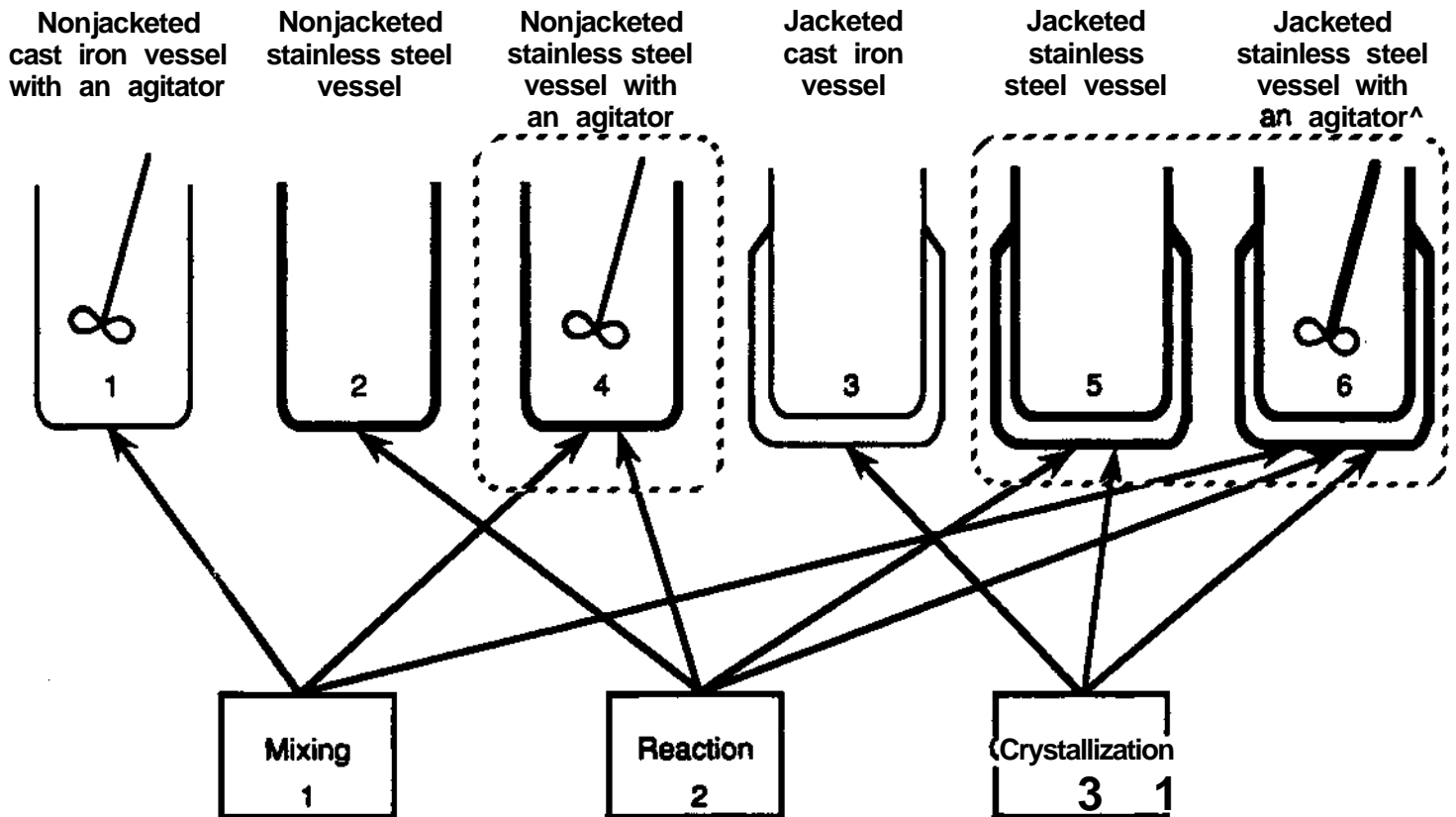

Figure 4(b) : Parallel Equipment



(a) Units with Nominal Assignments of Tasks



(b) Potential Assignment of Tasks to Units

Figure 5: Units and Task Relationships

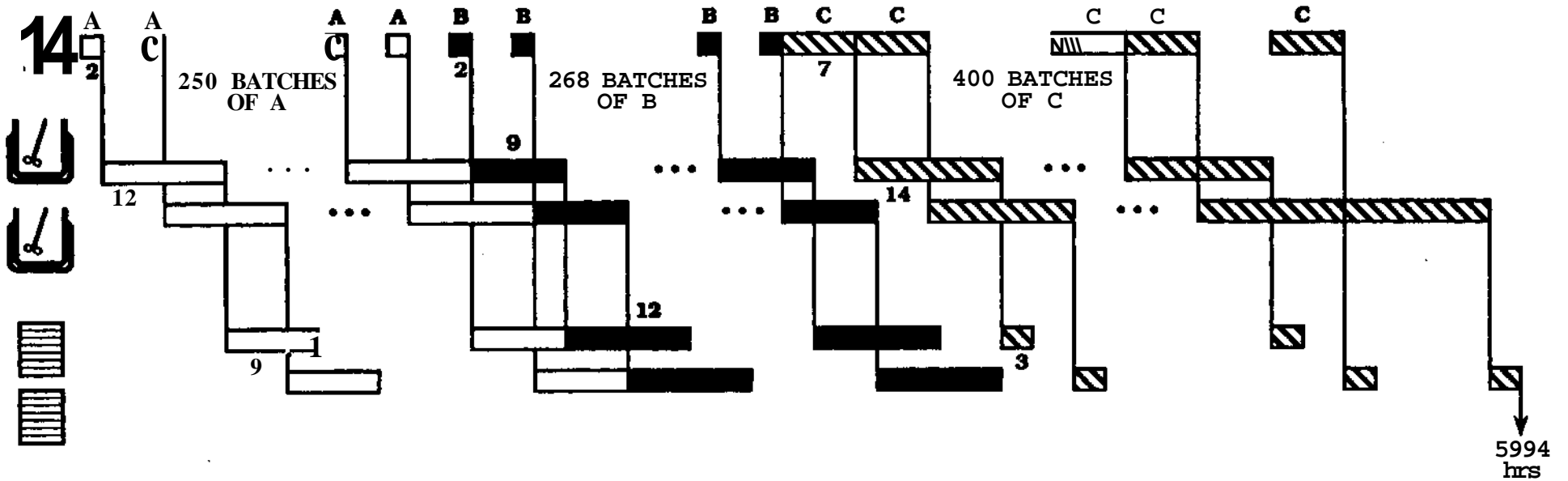
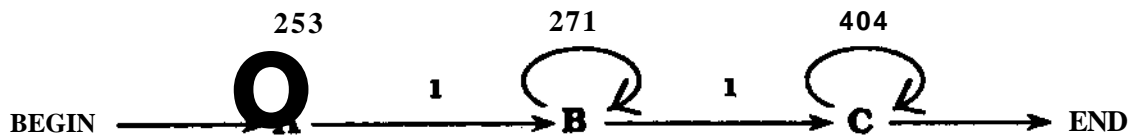
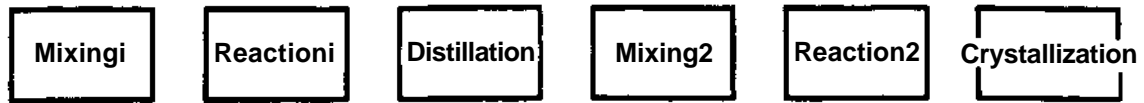

Figure 6(a) : Schedule for SPCs with ZW Policy



(a) Tasks To Be Performed

Cast Iron
Nonjacketed
with
Agitator

Cast Iron
Jacketed
with
Agitator

Distillation
Column

Cast Iron
Nonjacketed
with
Agitator

Stainless Steel
Nonjacketed
with
Agitator

Cast Iron
Jacketed

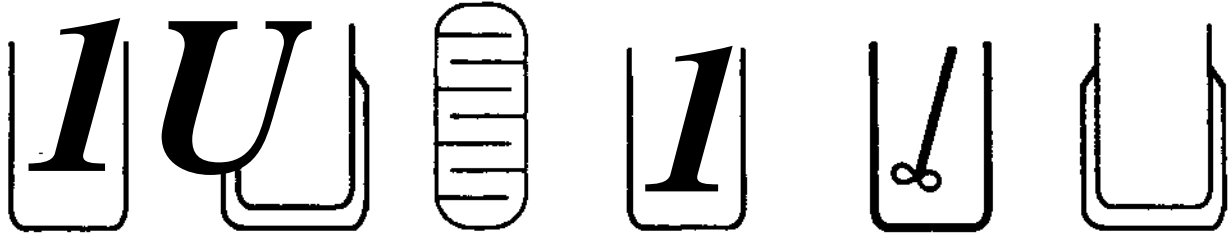

(b) Types of Units Available

Stainless Steel
Jacketed
with
Agitator



(c) Newly Added Superunit

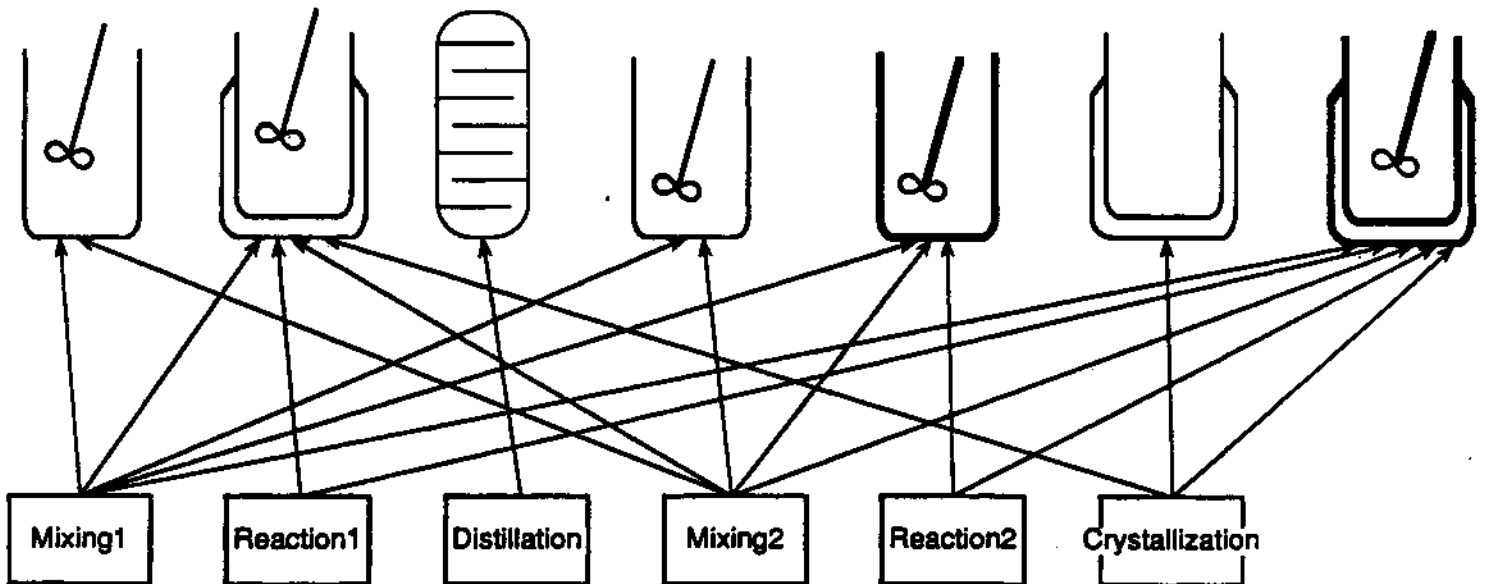

(d) Potential Assignments of Tasks to Units

Figure 7: Tasks and Units for Example 2

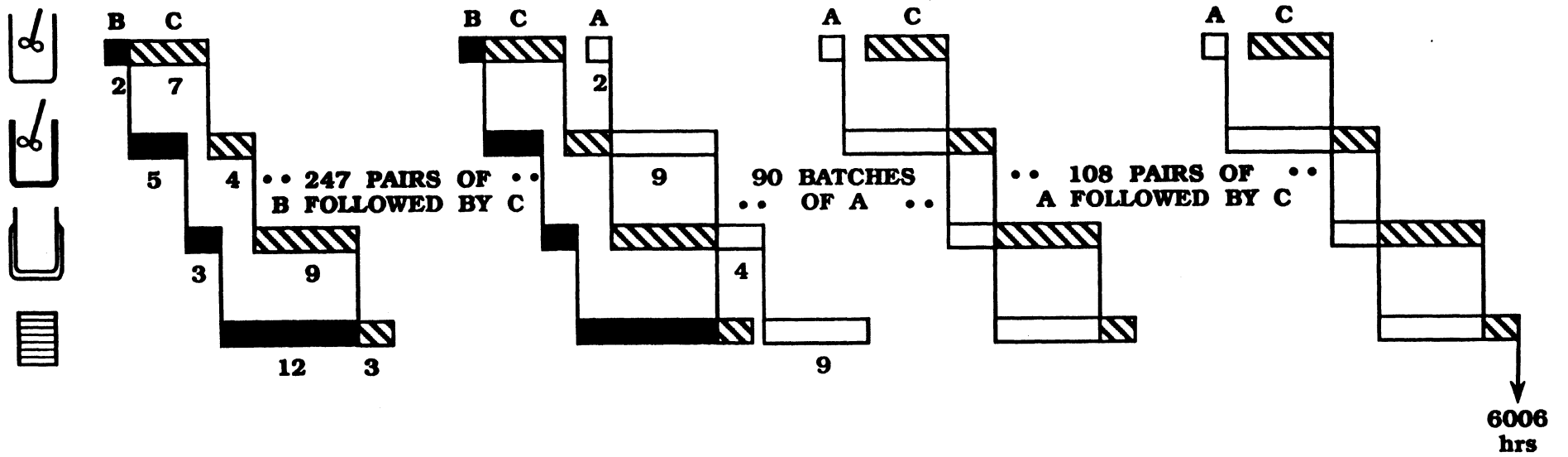
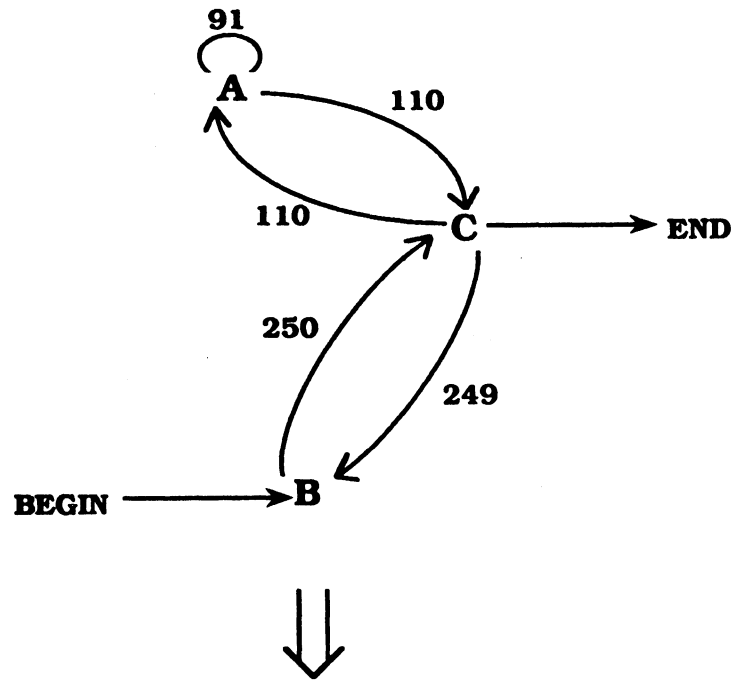
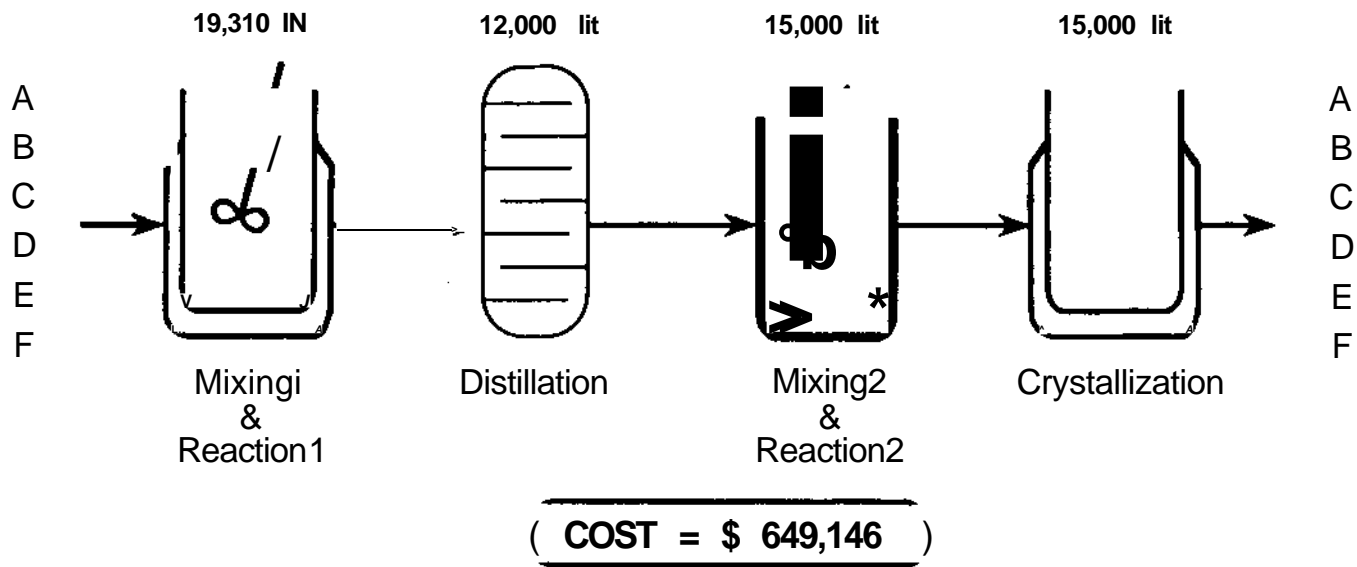
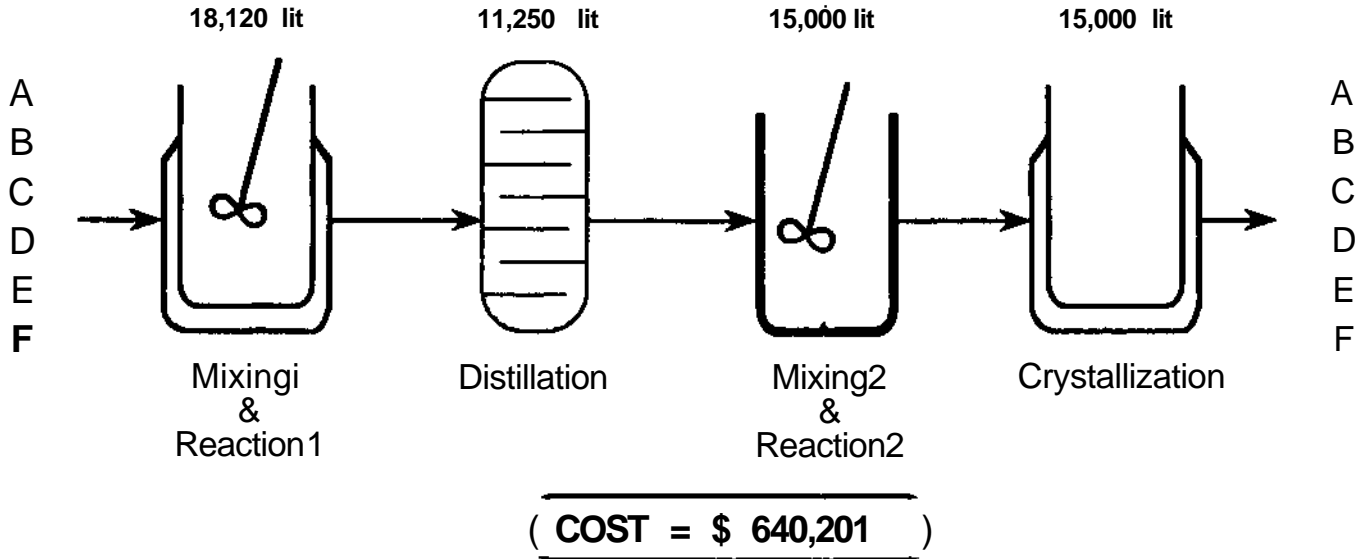

Figure 6(b) : Schedule for MPCs with ZW Policy



(c) Merging of Tasks and Parallel Equipment Allowed; Scheduling with MPCs [ZW]



(d) Merging of Tasks and Parallel Equipment Allowed; Scheduling with MPCs [UIS]

Figure 8: Batch Plant Designs for Example 2 (contd.)

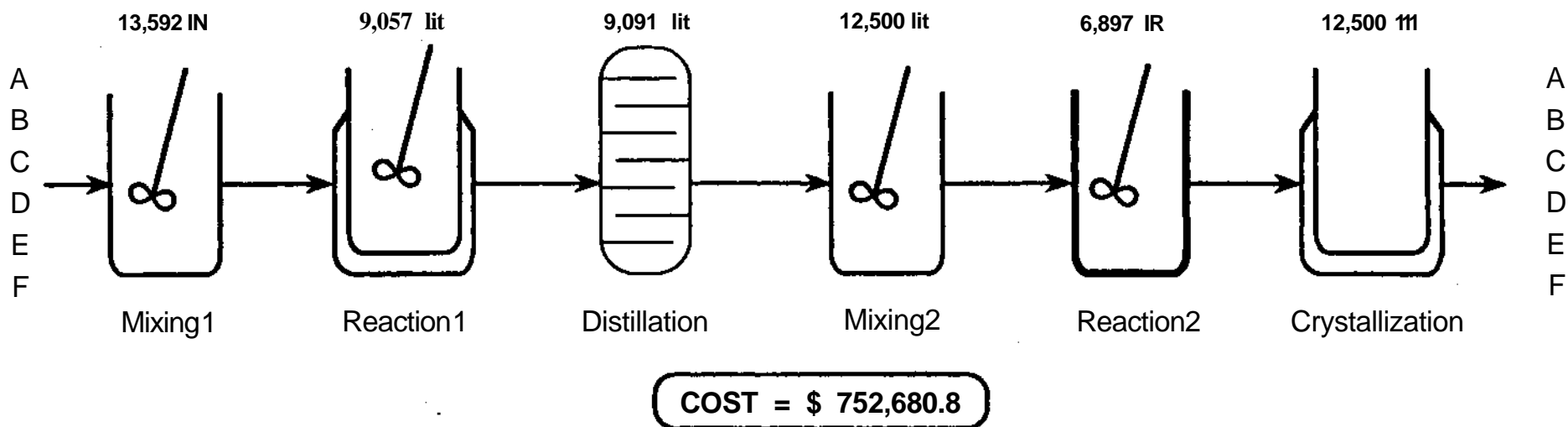

(a) Merging of Tasks and Parallel Equipment Not Allowed; Scheduling with SPCs Assumed

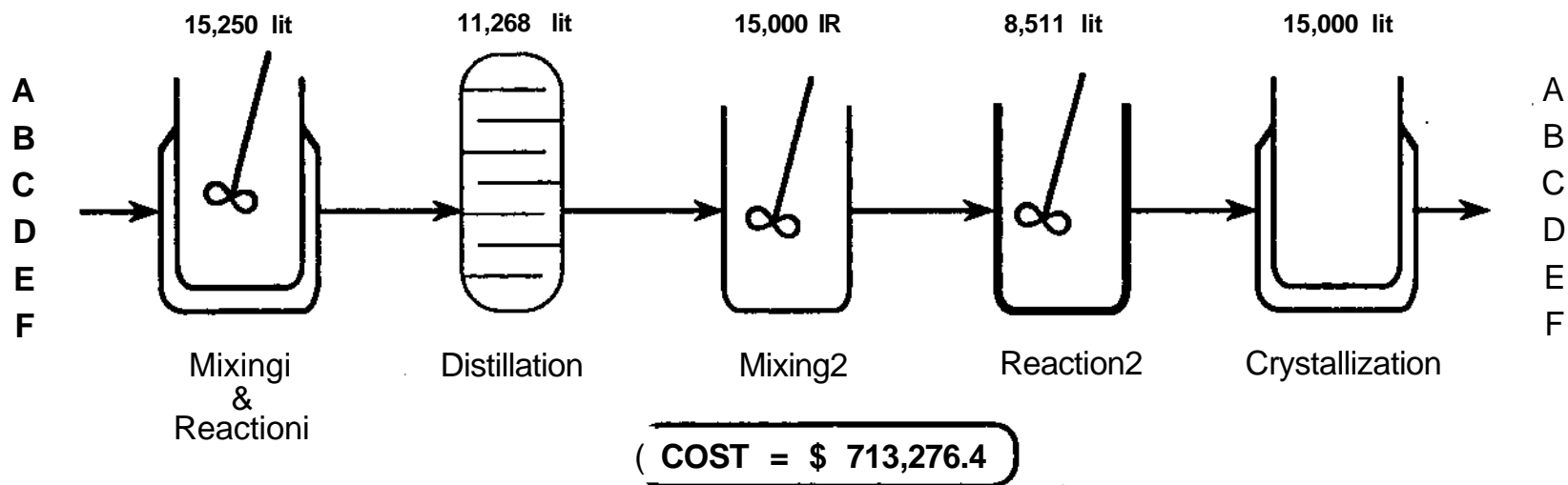

(b) Merging of Tasks and Parallel Equipment Allowed; Scheduling with SPCs Assumed

Figure 8: Batch Plant Designs for Example 2